

SPC-2140WP

21.5" Full HD TFT LED LCD
stationary Multi-Touch Panel
Computer with AMD dual-core
processor



product
design award

2013

NEW

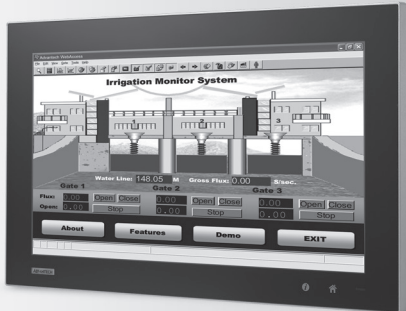

Features

- 21.5" Full HD TFT LED LCD display
- AMD dual-core 1.6GHz processor with independent GPU, advanced graphical performance
- 16:9 wide screen with PCT multi-touch
- Built-in function and home key button used for intuitive UI
- Anti-scratch touch surface: 7H hardness
- All around IP66 with waterproof M12 connector
- Support Mini-PCIe expansion slot
- Front LED indicator to show operating status
- Fanless cooling system
- Winner of the 2013 iF product design award

Introduction

With a brand-new ID design, the SPC-2140WP series provide high resolution 21.5" display and PCT multi-touch in 16:9 wide format. By embedding an AMD T56N 1.6GHz processor with independent GPU, the SPC-2140WP can support advanced graphical performance in more complex applications. Built-in function and home key button for greater user usability and operating safety. The SPC-2140WP also support Mini-PCIe slot for communication function expansion. Moreover, the SPC-2140WP includes an all around IP66 waterproof design with M12 connectors. With this vertical I/O connector, cable routing can be an easy job in stationary / VESA Arm applications.

Specifications

General

- **Certification** BSMI, CCC, CE, FCC Class A, UL
- **Cooling System** Fanless design
- **Dimensions (W x H x D)** 558.4 x 349.8 x 65 mm (21.98" x 13.77" x 2.56")
- **Enclosure**
 - Front bezel: Die-cast Aluminium alloy
 - Back housing: Die-cast Aluminium alloy
- **Mounting** VESA Arm
- **OS Support** Microsoft® Win7/8/WES7P/XP/WES2009/Linux
- **Power Consumption** 35 W Typical
- **Power Input** 24 V_{DC}
- **Weight (Net)** 9 kg (19.8 lbs)

System Hardware

- **CPU** AMD G-series T56N 1.6GHz
- **Chipset** AMD A50M FCH
- **Memory** 4GB SO-DIMM DDR3 SDRAM
- **LAN** 10/100/1000Base-T x 2 (connection: M12 A-coded, 8-pin female)
- **Expansion Slots** Full-sized Mini PCIe slot x 1 (optional)
- **Storage** 2.5" SATA HDD bracket x 1
- **I/O** RS-232 x1 (connection: M12 A-coded, 8-pin male)
USB 2.0 x1 (connection: M12 A-coded, 8-pin female)
24 V_{DC} power input (connection: M12 A-coded, 5-pin male)

LCD Display

- **Display Type** Full HD TFT LED LCD
- **Display Size** 21.5"
- **Max. Resolution** 1920 x 1080
- **Max. Colors** 16.7 M
- **Luminance cd/m²** 300
- **Viewing Angle (H/V°)** 178/178
- **Backlight Life** 50,000 hrs

Touchscreen

- **Light Transmission** ≥88%
- **Resolution** 4096*4096 dot
- **Type** Projected capacitive

Environment

- **Humidity** 10 ~ 95% RH @ 40°C, non-condensing
Note: Tested for 48hrs
- **Ingress Protection** All around IP66
- **Operating Temperature** 0 ~ 55°C (32 ~ 131°F)
- **Storage Temperature** -20 ~ 60°C (-4 ~ 140°F)
- **Vibration Protection** With HDD: 1 Grms (5 ~ 500 Hz)
(Operating, random vibration)

Rear View

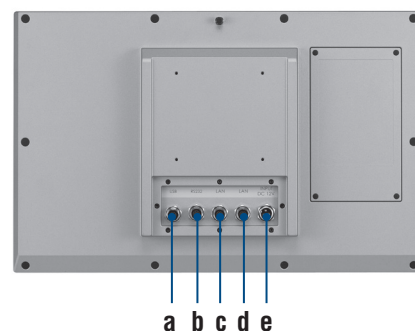

- a. USB 2.0 with M12 connector
- b. COM (RS-232) with M12 connector
- c. LAN 1 with M12 connector
- d. LAN 2 with M12 connector
- e. 24 V_{DC} input with M12 connector

Dimensions

Unit: mm

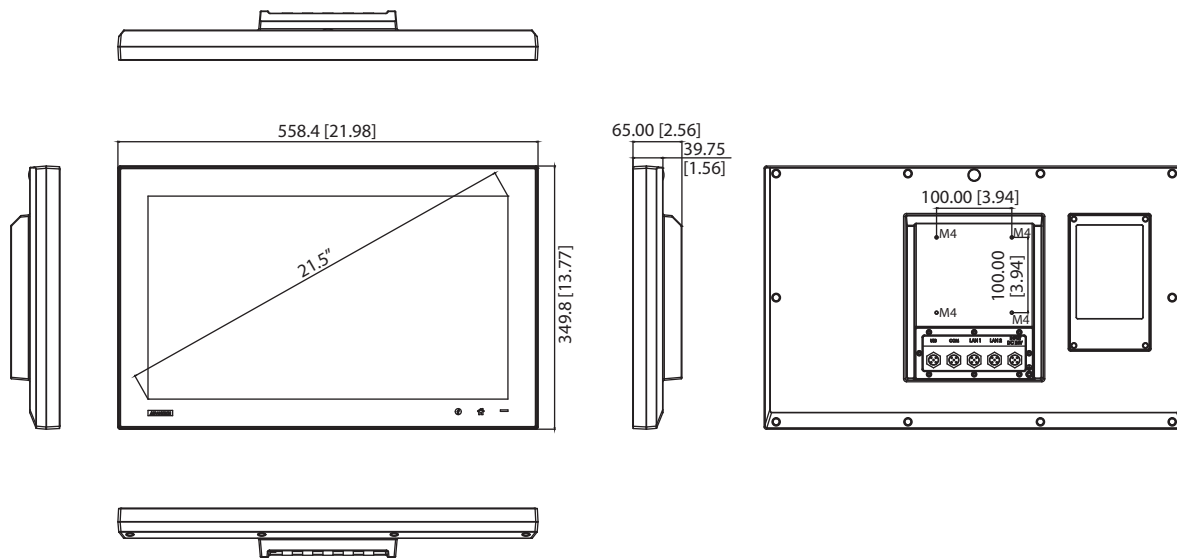

Ordering Information

- **SPC-2140WP-T3AE** 21.5" full-HD stationary Multi-Touch Panel PC, 4GB
- **WA-SPC2140WP** SPC-2140WP-T3AE with WebAccess software





Accessories

- **PWR-247-BE** 63W DC 24V/2.62A Output Power Supply
- **1702002600** Power Cable US Plug 1.8 M
- **1702002605** Power Cable EU Plug 1.8 M
- **1702031801** Power Cable UK Plug 1.8 M
- **1700000596** Power Cable China/Australia Plug 1.8 M
- **EWM-W151H01E** 802.11bgn RTL8188EE 1T1R, Half-size Mini-PCle (also need 9656EWMG00E)
- **9656EWMG00E** Half-size miniPCle to Full-size miniPCle bracket set
- **1750000318** EMI Antenna 2DBI 2.4GHz SMA CONN for ARK-3384
- **1750003222** 802.11b/g 5dBi Dipole Antenna
- **1750003418** Wireless Antenna AN2400-5901RS R/P SMA.M9dB
- **SPC-1840WP-MCKE** M12 cable accessory kit for SPC series
- **SPC-1840WP-MOKE** M12 Connector accessory kit for SPC series

Automation Software

- **968WEXP003X** PanelExpress V2.0 300 tags S/W license
- **968WEXP015X** PanelExpress V2.0 1500 tags S/W license
- **968WEXP050X** PanelExpress V2.0 5000 tags S/W license
- **968WEXP2USB** PanelExpress V2.0 S/W USB dongle

Application Software

	<p>Version : V2.1 or above</p> <p>An innovative remote device management software, allowing efficient remote monitoring, quick recovery & backup, and real-time remote configuration, to create a more intelligent and interconnected embedded computing solution.</p>
	<p>Version : V7.1 or above</p> <p>WebAccess, as the core of Advantech's IoT solution, is full web browser-based software package for HMI and SCADA software. All HMI and SCADA software features including: Animated Graphics Displays, Real-time Data, Control, Trends, Alarms and Logs, are available in a standard web browser. WebAccess is built around the latest internet technologies. With its open architecture, vertical domain applications can easily be integrated.</p>
	<p>Version : V2.0.3.8 or above</p> <p>Panel Express, a windows based HMI mini SCADA, realizes the cross platform flexibility offered by WebOP Designer to switch hardware for the consideration of cost and performance become an easy job. Panel Express software provides the best economic and express solution for data intensive high-end HMI applications.</p>
	<p>Version : V2.0.3.8 or above</p> <p>An easy to use integrated development tool featuring solution-oriented screen objects, high-end graphics, Windows fonts for multi-language applications. WebOP runtime, a part of WebOP Designer, guarantees reliability and performance because of the minimum system overhead, high communication data rates, and sub-second screen switching.</p>